



FURNITURE CATALOGUE PAVILION OF DENMARK

 STANDESIGN

 RÅDGIVNING  DESIGN  HÅNDVÆRK  TEKNOLOGI

Nor-Fishing 2022
23.08.2022 - 26.08.2022
Trondheim Spektrum, Trondheim

TABLE - STANDARD

Bord - Standard

Description

Table in suitable height for standard chairs.
Table top is laminated.
Stem and base are powder coated.

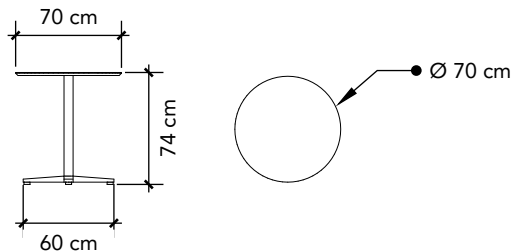

Order Form Title:
- Table, standard

Colour:

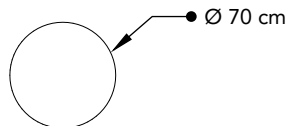
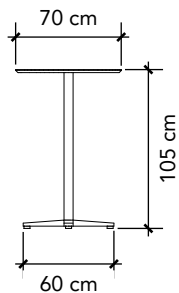

TABLE - BAR

Bord - Barbord

Description

Table in suitable height for bar chairs or standing.
Table top is laminated.
Stem and base are powder coated.



Order Form Title:
- Table, bar

Colour:
 White

CHAIR - STANDARD

Stol - Standard

Description

Chair with seat height suitable for standard table.
The seat is laminated wood.
Frame is in brushed steel.
The chair is stackable.

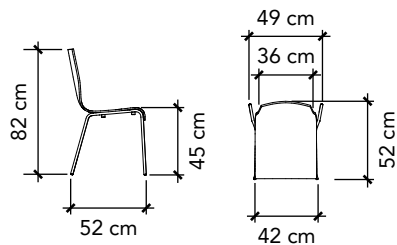

Order Form Title:
- Chair, standard

Colour:



CHAIR - BAR

Stol - Barstol

Description

Bar chair with seat height suitable for bar table.
The seat is laminated wood.
Frame is in brushed steel.
The chair is stackable.

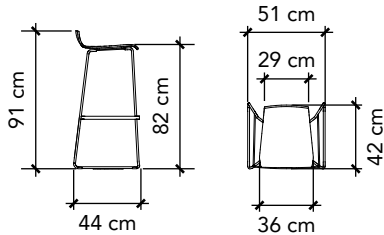
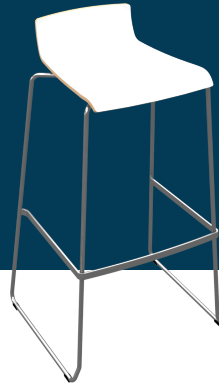

Order Form Title:
- Chair, bar

Colour:



White

BROCHURE DISPLAY - SWING-UP

Brochureholder - Swing-Up

Description

Brochure stand in black powder-coated steel.
There are 5 shelves with room for A4 brochures.

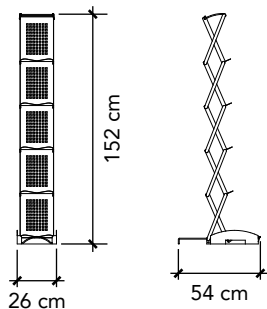

Order Form Title:
- Brochure Stand, Swing-Up

Colour options:



Black

COUNTER - STANDARD

Info disk - Standard

Description

Spray painted for smooth finish.
Front can be fitted with printed surface.
2 lockable cabinets at 60 cm and 40 cm width.
1 shelf in each cabinet.

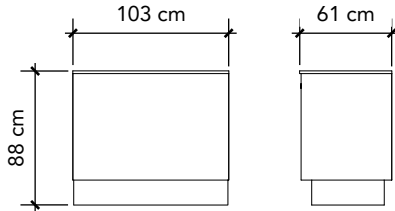

Graphics Dimensions:

Front: W 1030 mm x H 704 mm

Print INFO:

- Print ready PDF file
(or logo in vector format (EPS or AI))
- Add 10 mm bleed
- All text must be outlined
- All images must be 100 dpi
- All colors will be printed in CMYK

Order Form Title:

- Info Counter, standard

Colour:



COUNTER - BAR TOP

Info disk med serveringstop

Description

Spray painted for smooth finish.
Front can be fitted with printed surface.
2 lockable cabinets at 60 cm and 40 cm width.
1 shelf in each cabinet.

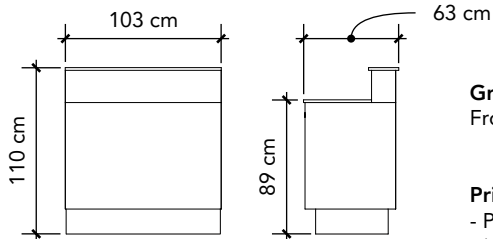

Graphics Dimensions:

Front: W 1030 mm x H 917 mm

Print INFO:

- Print ready PDF file
(or logo in vector format (EPS or AI))
- Add 10 mm bleed
- All text must be outlined
- All images must be 100 dpi
- All colors will be printed in CMYK

Order Form Title:

- Info Counter, w/ bar top

Colour:



COUNTER - OCTANORM

Info disk - Octanorm

Description

Info counter made in our standard framing system.
Front can be fitted with printed surface.
Internal storage on a shelf.
Sliding doors on back side.
These doors are NOT lockable.

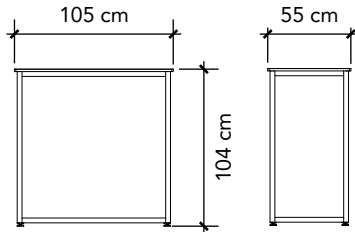
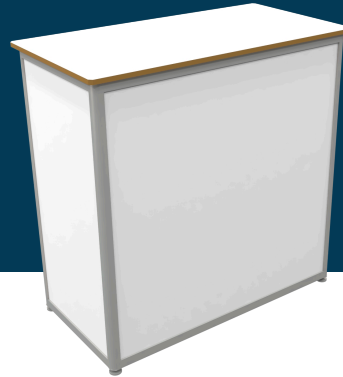

Graphics Dimensions:

Front:

Panel size: W 964 mm x H 950 mm
(Visible area: W 950 mm x H 936 mm)

Print INFO:

- Print ready PDF file
(or logo in vector format (EPS or AI))
- Add 10 mm bleed
- All text must be outlined
- All images must be 100 dpi
- All colors will be printed in CMYK

Order Form Title:

- Info Counter, OCTANORM system

Colour:



PODIUMS - STANDARD

Podie - Standard

Description

Podium in a painted matte finish.
Used for product display.
All sides can be fitted with printed surface.
Available in two different heights.

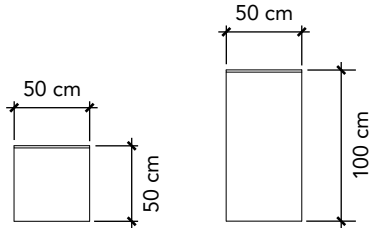
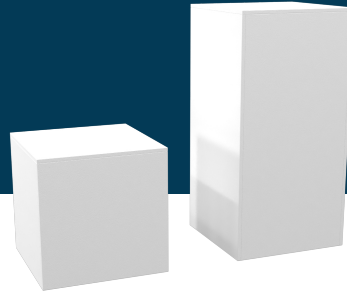

Graphics Dimensions:

Low: W 2000 mm x H 500 mm

High: W 2000 mm x H 1000 mm

Print INFO:

- Print ready PDF file
(or logo in vector format (EPS or AI))
- Add 10 mm bleed
- All text must be outlined
- All images must be 100 dpi
- All colors will be printed in CMYK



Order Form Title:

- Podium, standard, low - White
- Podium, standard, high - White

Colour:



White

PODIUM - CABINET

Podie - Skab

Description

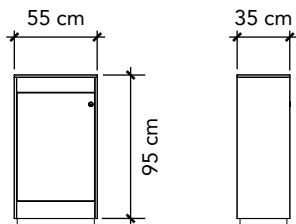

Podium with cabinet in a painted matte finish.
Used for product display (or monitor).
Lockable cabinet.
1 shelf in cabinet.



Order Form Title:

- Podium, cabinet - White
- Podium, cabinet - Black

Colour:

-  White
-  Black

MONITORS - LED

Skærme - LED

Description

Monitor of different brands and sizes.
LED (the newer version of LCD).
Used for videos or other media.
Connection to PC possible.
HDMI cable included.

Insurance included.

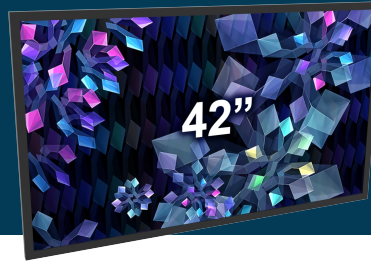
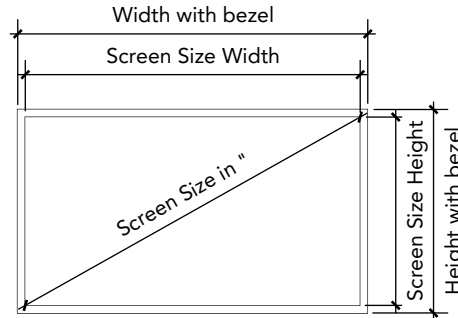

Image above is an example of a 42" monitor.

Size info (with bezel*):

- 32" = W 708 x H 398 mm (768 x 458 mm)
- 42" = W 930 x H 523 mm (990 x 583 mm)

*Bezels varies from model to model.
These are just approximate values.



Order Form Title:

- Monitor, LED - 32"
- Monitor, LED - 42"

MONITOR FLOOR STAND

Fod til skærm

Description

Monitor floor stand for monitors up to 42".
The base is galvanized cast iron.
The stem is aluminum matte finish.

Monitor NOT included.

Maximum height for top of monitor = 2 m

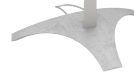
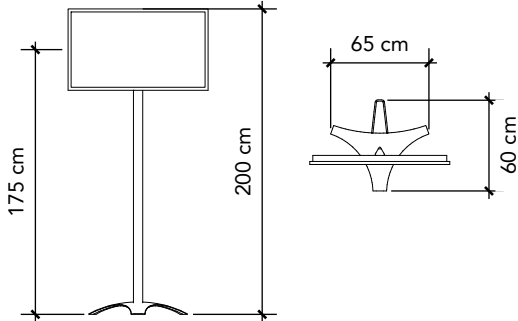
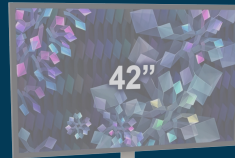

Order Form Title:
- Monitor Floor Stand

Colour of stem + base:

