

POSIDONIA 2026 ATHENS
01.06.2026 - 05.06.2026



STANDESIGN A/S - RØMSTØVEJ 24 - 5800 NYBORG, DENMARK
T: +45 44466979 - E: INFO@STANDESIGN.DK

TABLE - STANDARD

Bord - Standard

Description



Table in suitable height for standard chairs.
Table top is laminated wood.
Stem and base are powder-coated metal.



Order Form Title:

- Table - Standard, white
- Table - Standard, black

Colour options:

-  White
-  Black

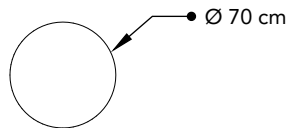
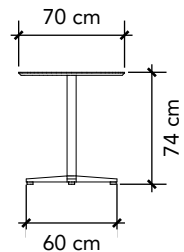

TABLE - BAR

Bord - Barbord



Description

Table in suitable height for bar chairs or standing.
Table top is laminated wood.
Stem and base are powder-coated metal.

Order Form Title:

- Table - Bar, white
- Table - Bar, black

Colour options:

-  White
-  Black

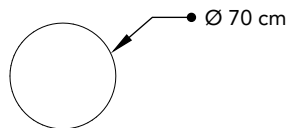
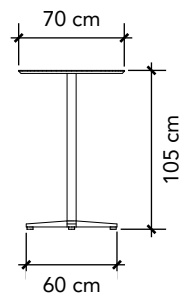

CHAIR - STANDARD

Stol - Standard

Description

Chair with seat height suitable for standard table.
The seat is laminated wood.
Frame is in brushed steel.
The chair is stackable.



Order Form Title:
- Chair - Standard, white

Colour:
 White

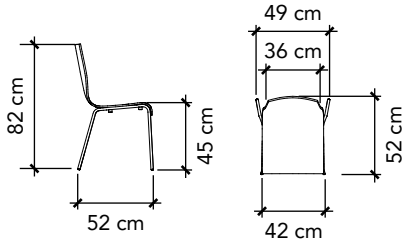

CHAIR - BAR

Stol - Barstol

Description

Bar chair with seat height suitable for bar table.
The seat is laminated wood.
Frame is in brushed steel.
The chair is stackable.



Order Form Title:
- Chair - Bar, white

Colour:
 White

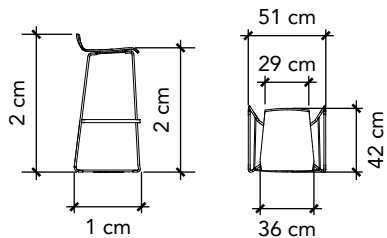

BROCHURE STAND - SWING-UP

Brochureholder - Swing-Up

Description

Brochure stand in black powder-coated steel.
There are 5 shelves with room for A4 brochures.

Order Form Title:
- Brochure stand - Swing-Up,
black

Colour:
 Black

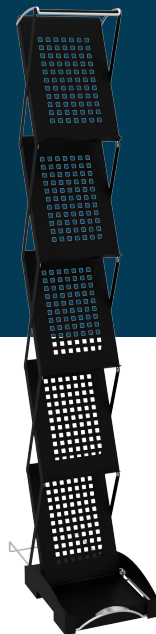
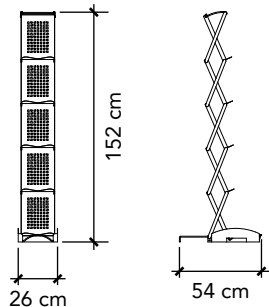

COUNTER - STANDARD

Info disk - Standard

Description

Spray painted for smooth finish.
Front can be fitted with printed surface.
2 lockable cabinets at 60 cm and 40 cm width.
1 shelf in each cabinet.



Order Form Title:
- Counter - Standard, white

Colour:
 White

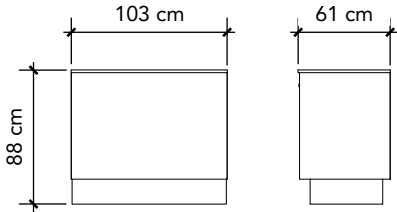

Graphics Dimensions:
Front: W 1030 mm x H 704 mm

Print INFO:

- Print ready PDF file
(or logo in vector format (EPS or AI))
- Add 10 mm bleed
- All text must be outlined
- All images must be 100 dpi
- All colors will be printed in CMYK

COUNTER - BAR TOP

Info disk - Serveringstop

Description

Spray painted for smooth finish.
Front can be fitted with printed surface.
2 lockable cabinets at 60 cm and 40 cm width.
1 shelf in each cabinet.



Order Form Title:
- Counter - Bar top, white

Colour:
 White

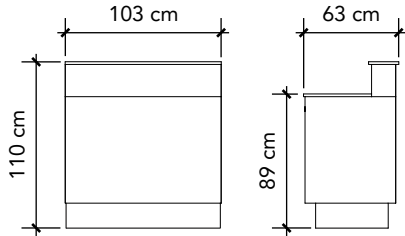

Graphics Dimensions:
Front: W 1030 mm x H 917 mm

Print INFO:

- Print ready PDF file
(or logo in vector format (EPS or AI))
- Add 10 mm bleed
- All text must be outlined
- All images must be 100 dpi
- All colors will be printed in CMYK

COUNTER - OCTANORM

Info disk - Octanorm

Description

Info counter made in our standard framing system.
Front can be fitted with printed surface.
Internal storage on a shelf.
Sliding doors on back side.
These doors are NOT lockable.

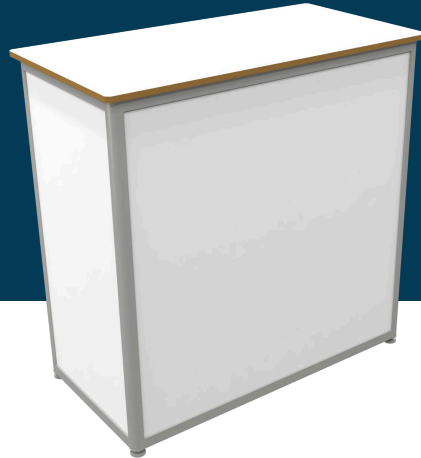

Order Form Title:

- Counter - Octanorm system,
white

Colour:

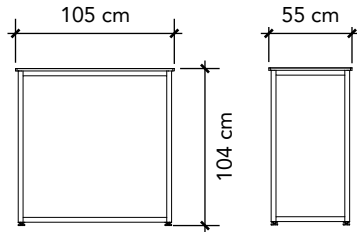

Graphics Dimensions:

Front:

Panel size: W 964 mm x H 950 mm
(Visible area: W 950 mm x H 936 mm)

Print INFO:

- Print ready PDF file
(or logo in vector format (EPS or AI))
- Add 10 mm bleed
- All text must be outlined
- All images must be 100 dpi
- All colors will be printed in CMYK

PODIUMS - STANDARD

Podie - Standard

Description

Podium in a painted matte finish.
Used for product display.
All sides can be fitted with printed surface.
Available in two different heights.

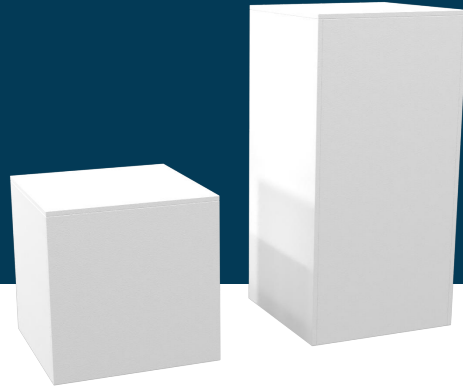

Order Form Title:

- Podium - Standard, low, white
- Podium - Standard, high, white

Colour:



White

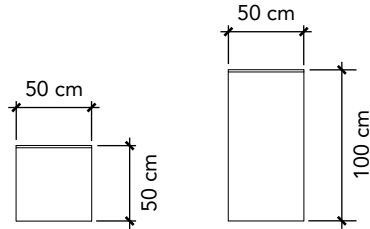

Graphics Dimensions:

Low: W 2000 mm x H 500 mm
High: W 2000 mm x H 1000 mm

Print INFO:

- Print ready PDF file
(or logo in vector format (EPS or AI))
- Add 10 mm bleed
- All text must be outlined
- All images must be 100 dpi
- All colors will be printed in CMYK

PODIUM - CABINET

Podie - Skab

Description



Podium with cabinet in a painted matte finish.
Used for product display (or monitor).
Lockable cabinet.
1 shelf in cabinet.



Order Form Title:

- Podium - Cabinet, white
- Podium - Cabinet, black

Colour options:

-  White
-  Black

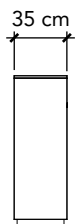
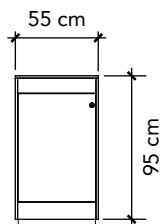

Description

Monitor of different brands and sizes.
LED display screen.
Used for videos or other media.
Connection to PC possible - USB and HDMI ports.
HDMI cable included.

Insurance included.

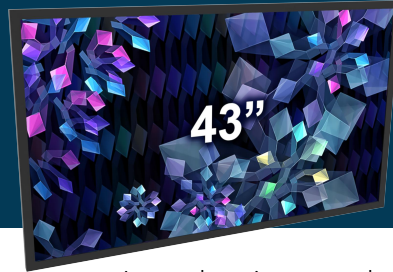
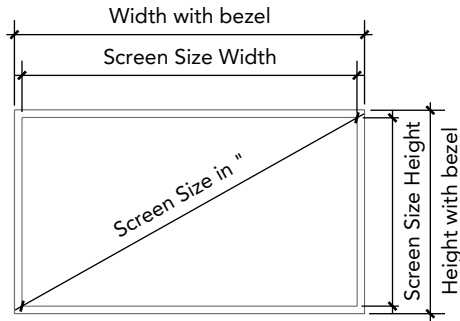

Image above is an example of a 43" monitor.

Order Form Title:

- Monitor - LED - 32"
- Monitor - LED - 43"
- Monitor - LED - 55"
- Monitor - LED - 65"
- Monitor - LED - 75"



Size info (with bezel*):

- 32" = W 708 x H 398 mm (768 x 458 mm)
- 43" = W 952 x H 535 mm (992 x 575 mm)
- 55" = W 1218 x H 685 mm (1258 x 725 mm)
- 65" = W 1440 x H 810 mm (1480 x 850 mm)
- 75" = W 1661 x H 935 mm (1701 x 975 mm)

*Bezels varies from model to model.
These are just approximate values.

MONITOR FLOOR STAND

Fod til skærm

Description

Monitor floor stand for monitors up to 55".
The base is galvanized cast iron.
The stem is aluminum matte finish.

Monitor NOT included.
Maximum height for top of monitor = 2 m

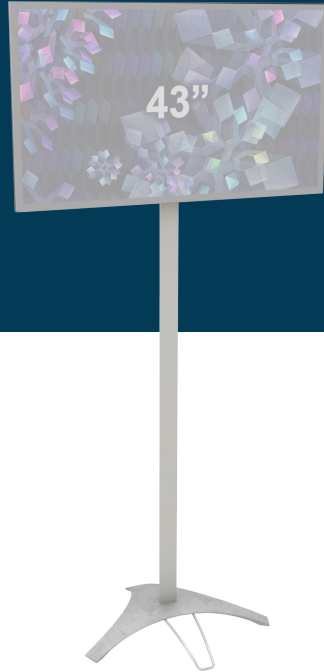

Order Form Title:
- Monitor floor stand

Colour:
 Metallic Gray

