

TABLE - STANDARD

Bord - Standard

Description



Table in suitable height for standard chairs.
Table top is laminated wood.
Stem and base are powder-coated metal.



Order Form Title:

- Table - Standard, white
- Table - Standard, black

Colour options:

-  White
-  Black

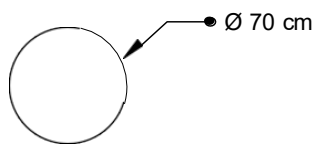
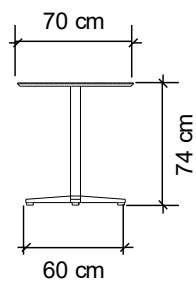

Price: 360,-

TABLE - BAR

Bord - Barbord



Description

Table in suitable height for bar chairs or standing.
Table top is laminated wood.
Stem and base are powder-coated metal.

Order Form Title:

- Table - Bar, white
- Table - Bar, black

Colour options:

-  White
-  Black

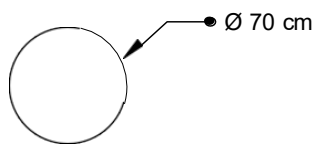
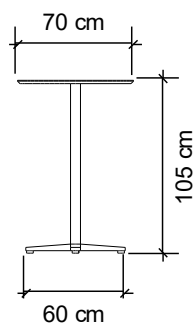

Price: 360,-

TABLE - U-TABLE

Bord - U-bord

Description

"Upside-down-edged-U-shape"
Bar table with chunky top and sides.
Spray painted for smooth finish.
Available in 3 different sizes:
Width: 50 cm, 100 cm and 150 cm

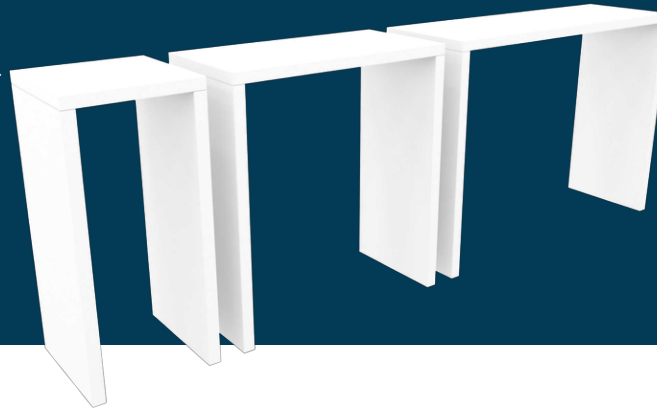

Order Form Title:

- Table, U-Table, W: 50cm
- Table, U-Table, W: 100cm
- Table, U-Table, W: 150cm

Colour:



Other colours and sizes are possible for an additional cost

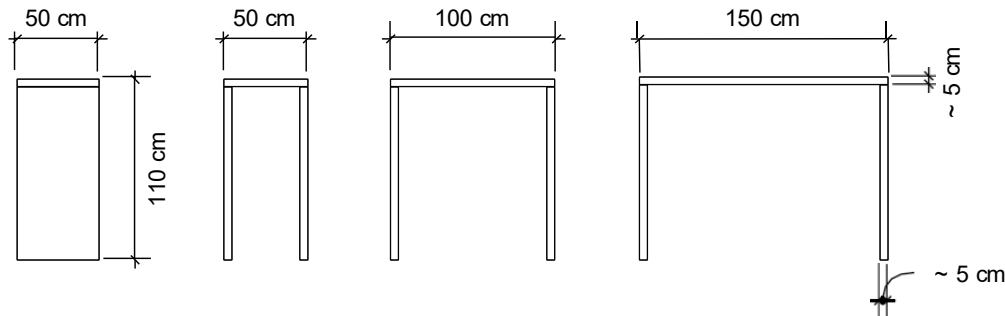

50cm - Price: 500,-
100cm - Price: 1000,-
150cm - Price: 1500,-

CHAIR - STANDARD

Stol - Standard

Description

Chair with seat height suitable for standard table.
The seat is laminated wood.
Frame is in brushed steel.
The chair is stackable.



Order Form Title:
- Chair - Standard, white

Colour:
 White

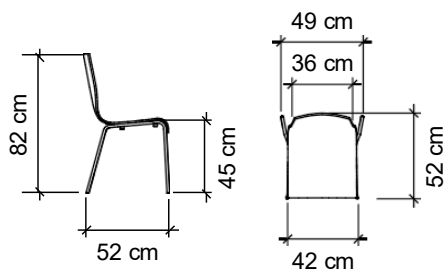

Price: 360,-

CHAIR - BAR

Stol - Barstol

Description

Bar chair with seat height suitable for bar table.
The seat is laminated wood.
Frame is in brushed steel.
The chair is stackable.

Order Form Title:
- Chair - Bar, white

Colour:
 White

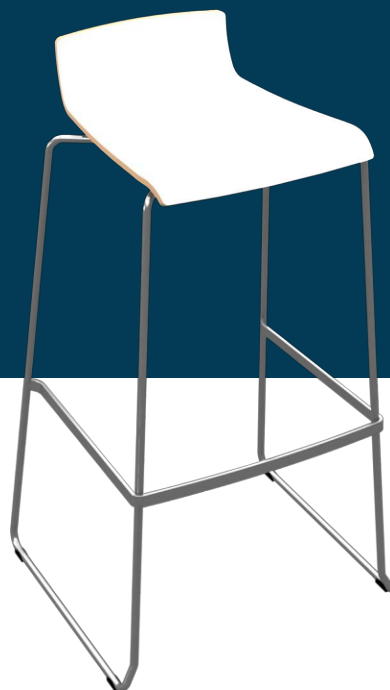
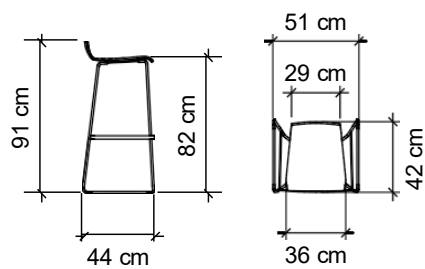

Price: 360,-

CHAIR - STANDARD AAC22

Stol - Standard, AAC22

Description

Chair with seat height suitable for standard table.
The seat is practical plastic in white.
Frame is made of oak.
The chair is not stackable.



Order Form Title:
- Chair, Standard, AAC22

Colour of frame:



Wood

Colour of seat:



White

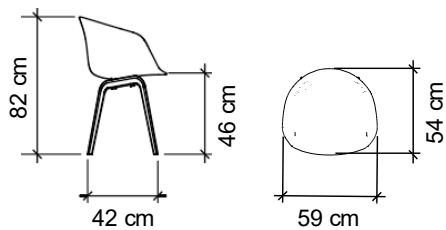

Price: 580,-



STANDESIGN

CHAIR - BAR AAS32

Stol - Barstol, AAS32

Description

Bar chair with seat height suitable for bar table.
The seat is practical plastic.
Frame is made of oak with footrest in brushed steel.
The chair is not stackable.



Order Form Title:
- Chair, Bar, AAS32

Colour of frame:



Wood

Colour of seat:



White

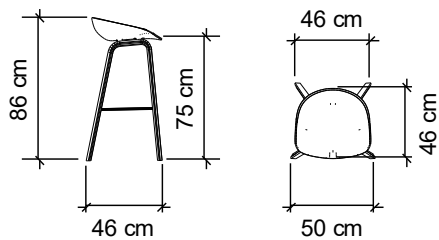

Price: 525,-



STANDESIGN

CHAIR - BAR NICE

Stol - Barstol, Nice

Description

Bar chair with seat height suitable for bar table.
The seat is upholstered in foam and faux leather.
Legs are made of metal with wood look.
Footrest in powder-coated metal.
The chair is not stackable.



Order Form Title:
- Chair, Bar, Nice

Colour of legs:



Wood

Colour of seat:



Black

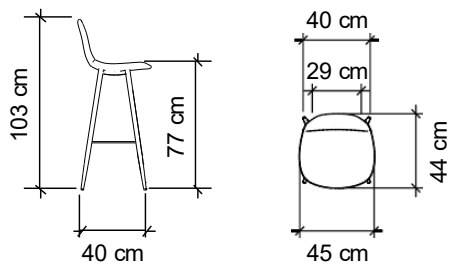

Price: 490,-

CHAIR - BAR BERN

Stol - Barstol, Bern

Description



Bar chair with seat height suitable for bar table.
The seat is upholstered in foam and faux leather.
Legs and footrest are powder-coated black steel.
The chair is not stackable.



Order Form Title:

- Chair, Bar, Bern, Black
- Chair, Bar, Bern, Cognac

Colour options:

-  Black
-  Cognac

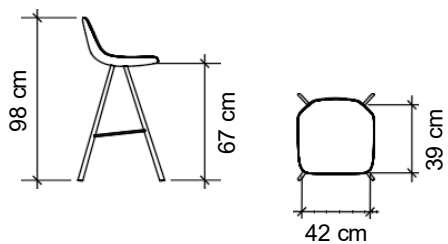

Price: 490,-

CHAIR - COMFORT PERPIGNAN

Stol - Komfort stol, Perpignan

Description

Chair with seat height suitable for standard table or coffee table.

The chair is upholstered in grey melange fabric.

The legs are made of oak.

The chair is not stackable.

Order Form Title:

- Chair, Comfort, Perpignan

Colour of legs:



Colour of seat:

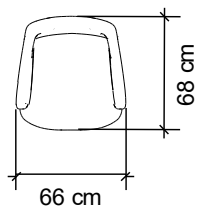
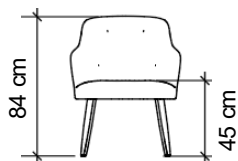
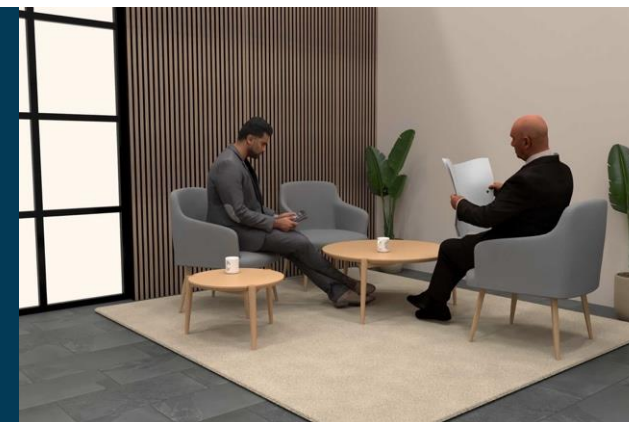

Price: 475,-

CHAIR - LOUNGE CAMBRIDGE

Stol - Lænestol, Cambridge

Description

Chair with seat height suitable for coffee table.
Upholstered in foam and brown faux leather.
Legs are powder-coated black steel.
Swivel chair.
The chair is not stackable.

Order Form Title:
- Chair, Lounge, Cambridge

Colour of legs:



Colour of seat:

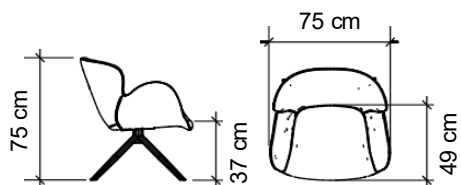
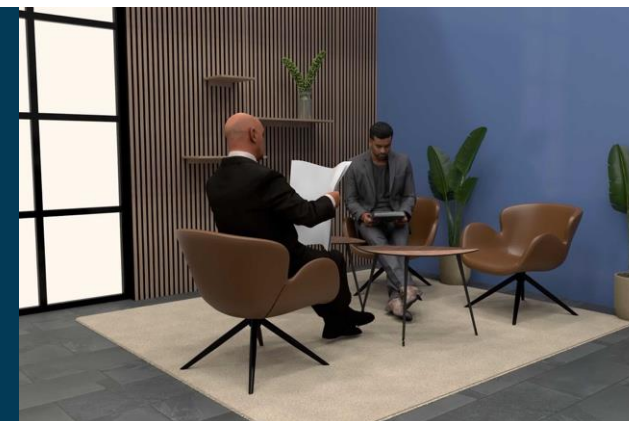

Price: 625,-

COUNTER - STANDARD

Info disk - Standard

Description

Spray painted for smooth finish.
Front can be fitted with printed surface.
2 lockable cabinets at 60 cm and 40 cm width.
1 shelf in each cabinet.



Order Form Title:
- Counter - Standard, white

Colour:
 White

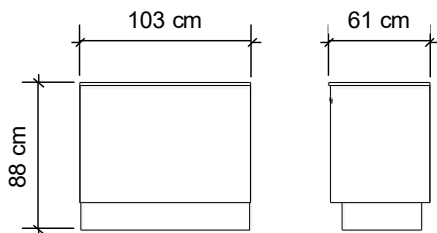

Graphics Dimensions:
Front: W 1030 mm x H 704 mm

Print INFO:

- Print ready PDF file
(or logo in vector format (EPS or AI))
- Add 10 mm bleed
- All text must be outlined
- All images must be 100 dpi
- All colors will be printed in CMYK

Price: 1575,-

COUNTER - BAR TOP

Info disk - Serveringstop

Description

Spray painted for smooth finish.
Front can be fitted with printed surface.
2 lockable cabinets at 60 cm and 40 cm width.
1 shelf in each cabinet.



Order Form Title:
- Counter - Bar top, white

Colour:
 White

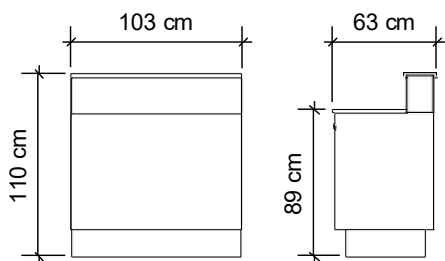

Graphics Dimensions:
Front: W 1030 mm x H 917 mm

Print INFO:

- Print ready PDF file
(or logo in vector format (EPS or AI))
- Add 10 mm bleed
- All text must be outlined
- All images must be 100 dpi
- All colors will be printed in CMYK

Price: 1575,-

COUNTER - OCTANORM

Info disk - Octanorm

Description

Info counter made in our standard framing system.
Front can be fitted with printed surface.
Internal storage on a shelf.
Sliding doors on back side.
These doors are NOT lockable.

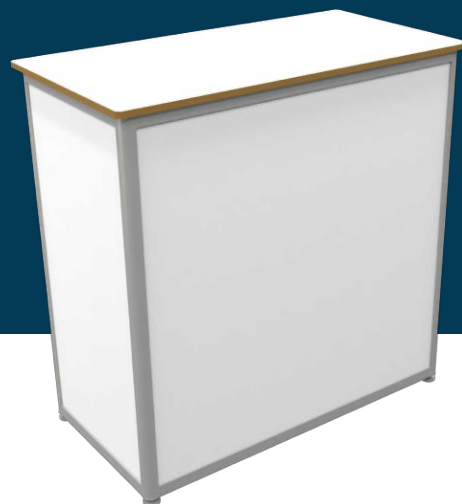

Order Form Title:

- Counter - Octanorm system,
white

Colour:



White

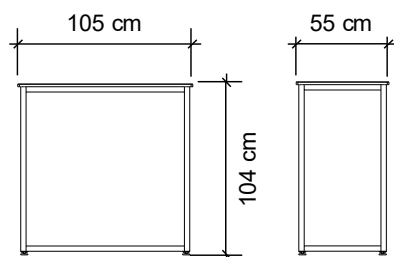

Graphics Dimensions:

Front:

Panel size: W 964 mm x H 950 mm

(Visible area: W 950 mm x H 936 mm)

Print INFO:

- Print ready PDF file
(or logo in vector format (EPS or AI))
- Add 10 mm bleed
- All text must be outlined
- All images must be 100 dpi
- All colors will be printed in CMYK

Price: 1210,-

COUNTER - DAYTONA

Info disk - Daytona

Description

Spray painted for smooth finish.
Slat panels in oak on front.
2 lockable cabinets 50 cm width.

Order Form Title:
- Counter - Daytona, Black

Colour:

 Black

 Wood

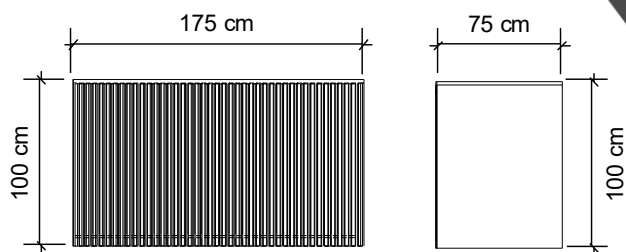
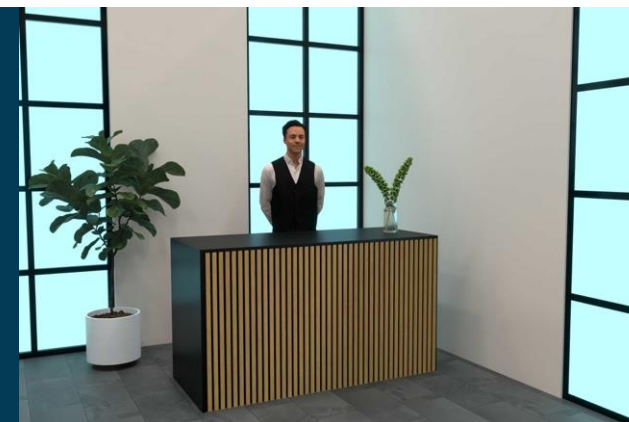

Price: 4750,-

PODIUMS - STANDARD

Podie - Standard

Description

Podium in a painted matte finish.
Used for product display.
All sides can be fitted with printed surface.
Available in two different heights.

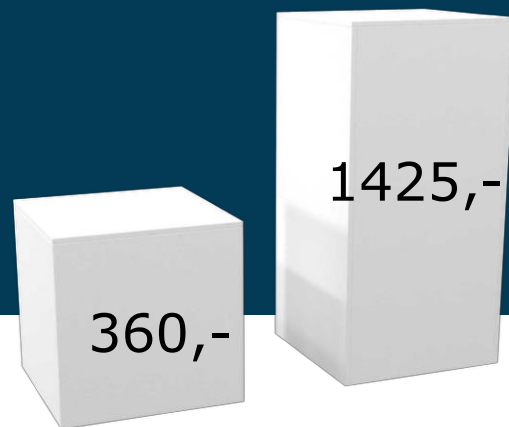

Order Form Title:

- Podium - Standard, low, white
- Podium - Standard, high, white
- Podium - Standard, low, black
- Podium - Standard, high, black

Colour options:

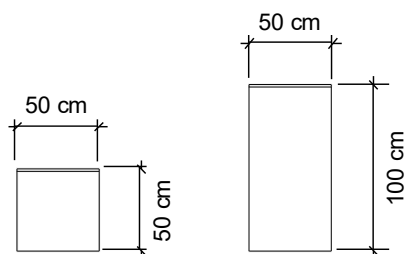

Other sizes and colours are possible for an additional cost

Graphics Dimensions:

Low: W 2000 mm x H 500 mm
High: W 2000 mm x H 1000 mm

Print INFO:

- Print ready PDF file
(or logo in vector format (EPS or AI))
- Add 10 mm bleed
- All text must be outlined
- All images must be 100 dpi
- All colors will be printed in CMYK

PODIUM - CABINET

Podie - Skab

Description

Podium with cabinet in a painted matte finish.
Used for product display (or monitor).
Lockable cabinet.
1 shelf in cabinet.



Order Form Title:

- Podium - Cabinet, white
- Podium - Cabinet, black

Colour options:

-  White
-  Black

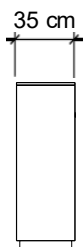
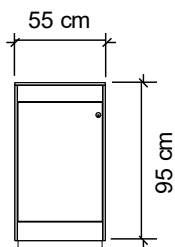

Price: 790,-

PANELS - ACOUSTIC SLATS

Akustikpaneler med lameller

Description

Panel with acoustic slats in light oak on black felt.
Mounted on booth walls for effect and accessories.
Available in 2 standard sizes.

Order Form Title:

- Panel - Acoustic, 496x2480mm
- Panel - Acoustic, 992x2480mm

Colour of slat:



Colour of felt:

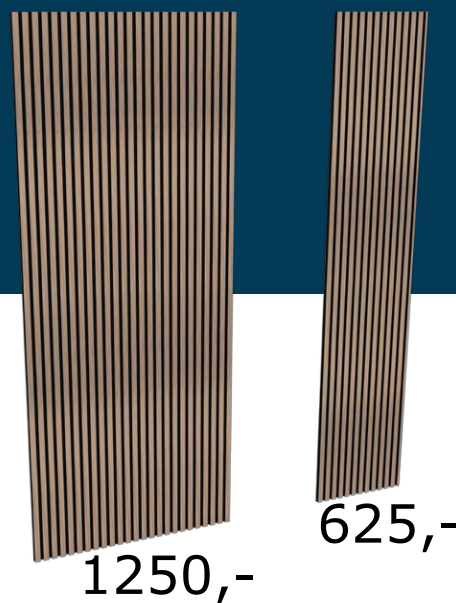
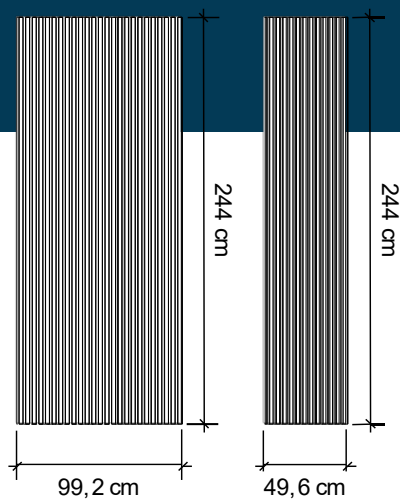
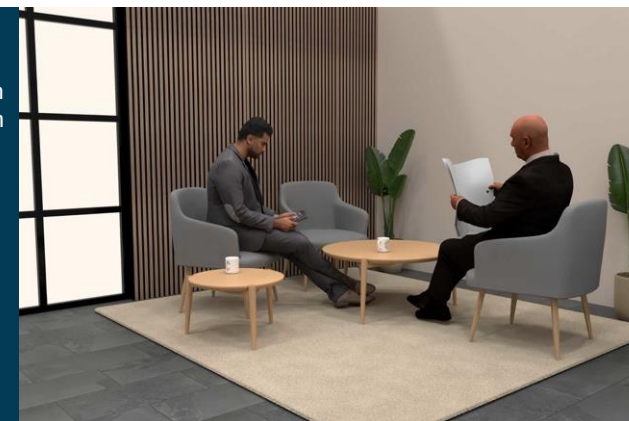

SHELVES - FOR ACOUSTIC SLAT PANELS

Hylde til akustikpaneler med lameller

Description

Hanging shelves in light oak, same as slats on acoustic panels.

Mounted on panel walls.

Available in 3 standard sizes.

Order Form Title:

- Shelf for Panel, 300x270mm
- Shelf for Panel, 600x270mm
- Shelf for Panel, 900x270mm

Colour:

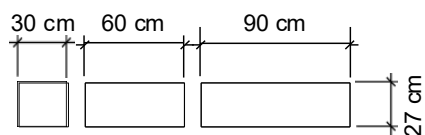

MONITORS - LED

Skærme - LED

Description

Monitor of different brands and sizes.
LED display screen.
Used for videos or other media.
Connection to PC possible - USB and HDMI ports.
HDMI cable included.

Insurance included.



Image shown is an example of a 43" monitor.

Order Form Title:

- Monitor - LED - 32"
- Monitor - LED - 43"
- Monitor - LED - 55"
- Monitor - LED - 65"
- Monitor - LED - 75"

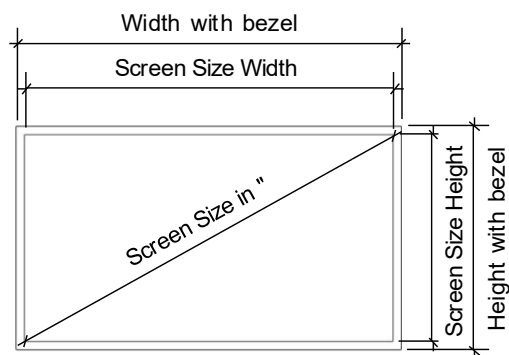

32" - 2500,-
43" - 3400,-
55" - 4400,-
65" - 5200,-
75" - 6000,-

Size info (with bezel*):

- 32" = W 708 x H 398 mm (768 x 458 mm)
- 43" = W 952 x H 535 mm (992 x 575 mm)
- 55" = W 1218 x H 685 mm (1258 x 725 mm)
- 65" = W 1440 x H 810 mm (1480 x 850 mm)
- 75" = W 1661 x H 935 mm (1701 x 975 mm)

*Bezels varies from model to model.
These are just approximate values.

MONITOR FLOOR STAND

Fod til skærm

Description

Monitor floor stand for monitors up to 55".
The base is galvanized cast iron.
The stem is aluminum matte finish.

Monitor NOT included.
Maximum height for top of monitor = 2 m

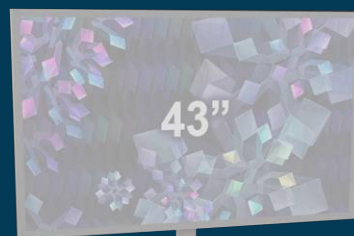

Order Form Title:
- Monitor floor stand

Colour:
 Metallic Gray

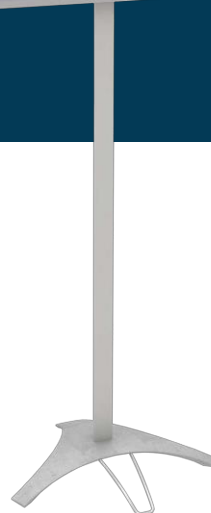
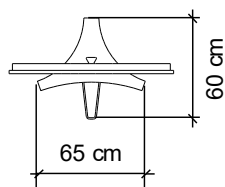
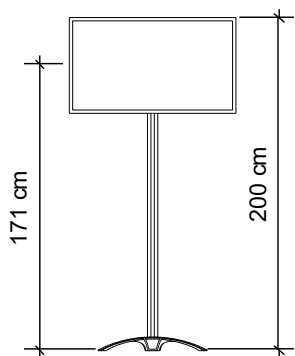

Price: 4750,-

TOUCH SCREEN STAND 55" - FABRIC FRONT

Touch screen stander 55" - Fabric Front



Description

Touch screen stand 55" in a painted matte finish.
Fabric on front - regular or backlit.

Order Form Title:

- Touch Screen Stand 55" -
Fabric Front

Colour options:

-  White
-  Black

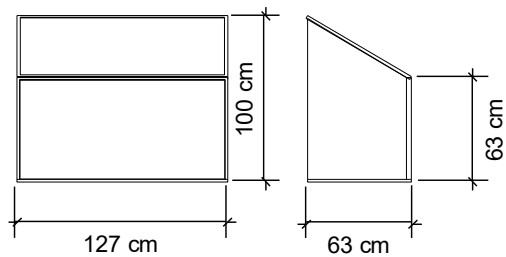

Graphics Dimensions:

Front: W 1238 mm x H 600 mm

Print INFO:

- Print ready PDF file
(or logo in vector format (EPS or AI))
- Add 20 mm bleed
- All text must be outlined
- All images must be 100 dpi
- All colors will be printed in CMYK

Price: 10.500,-

MODULES - LED TILES

LED-moduler - Kvadrater

Description

Modular Hi-LED Tiles; squares of 0,5 x 0,5 m
Numerous combination options and seamlessly integrated with our frame system.

Order Form Title:

- Hi-LED Tile - 496 x 496 mm

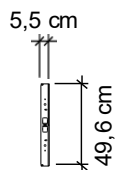
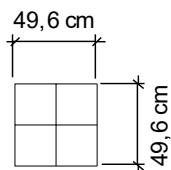
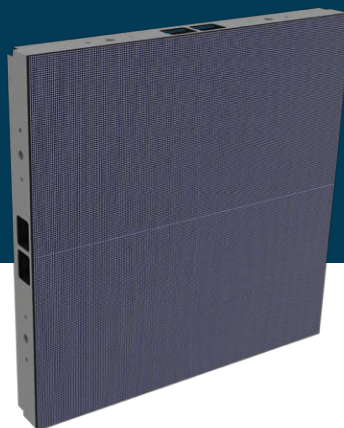

Price: 1200,- pr tile (0,5x0,5 meters)
+ Controller up to 34 tiles, Price: 3000,-

BROCHURE STAND - SWING-UP

Brochureholder - Swing-Up

Description

Brochure stand in black powder-coated steel.
There are 5 shelves with room for A4 brochures.

Order Form Title:
- Brochure stand - Swing-Up,
black

Colour:



Black

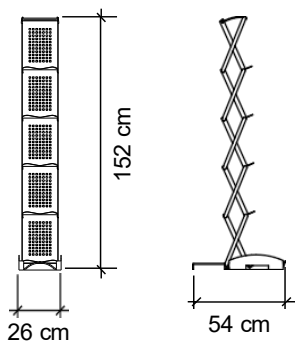

Price: 400,-



STANDESIGN

BROCHURE DISPLAY - ACRYLIC

Brochureholder - Akryl

Description

Transparent acrylic A4 or A5 brochure stand.
Variants for standing on table
or hanging on wall available.

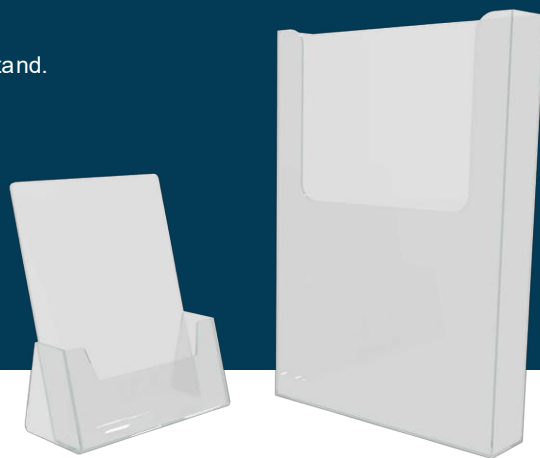

Order Form Title:

- Brochure Stand, acrylic, A4 table
- Brochure Stand, acrylic, A5 table
- Brochure Stand, acrylic, A4 wall
- Brochure Stand, acrylic, A5 wall

Colour options:

- Transparent Acrylic

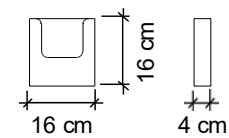
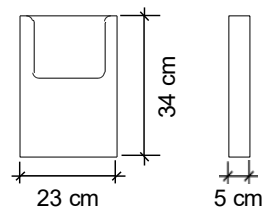
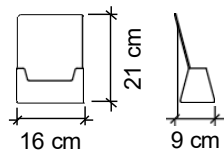
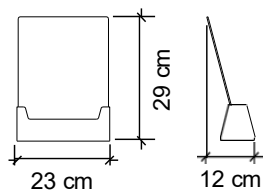

Price: 40,-

REFRIDGERATOR - ROUND - COOLER

Køleskab - Rund Vandkøler

Description

Round refrigerator with glass lid for easy access from the top. Ideal for cooling water bottles or other drinks. The whole side around it can be wrapped with custom print.



Order Form Title:

- Refrigerator, round, 'Water Cooler'

Colour options:



White

Other colours or custom print are possible for an additional cost



Graphics Dimensions:

Wrap: W 1775 mm x H 733 mm
(all the way around - see guide to the left)

Print INFO:

- Print ready PDF file
(or logo in vector format (EPS or AI))
- Add 10 mm bleed
- All text must be outlined
- All images must be 100 dpi
- All colors will be printed in CMYK

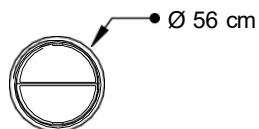
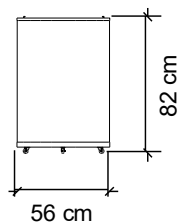

Price: 820,-
Print: 570,-

